

---

## REAL TIME TRAFFIC CONTROL UNDER TIME VARYING INCOMING FLOW RATES OF VEHICLES TO MINIMIZE WAITING TIME OF VEHICLES AT A ROAD INTERSECTION

**Yogeswary Raviraj\***  
**W.B.Daundasekera\*\***

---

### Abstract

This paper presents two real time non-linear programming models according to two special oversaturation conditions to minimize the aggregate delay time of vehicles and the number of vehicles at each lane by minimizing the total number of vehicles at the signalized intersection. These models are developed under time varying incoming flow rates of vehicles. The most important factor of traffic signal control is the number of vehicles in a queue at the lanes of intersection. The initial number of vehicles at each lane at the intersection is counted by a camera which is the most accurate method. The models are developed to minimize the number of vehicles from cycle to cycle. These proposed models include inter green signal time which is one of the key factors compared to other existing models proposed in the past research. These models also incorporate restrictions for upper bound for green signal time allocation which leads to accurate and appropriate allocation for green signal time. The lower bound of green signal time is attained by oversaturation conditions of the models. The proposed models are solved by the interior point algorithm method coded in MATLAB environment.

---

### Keywords:

Traffic signal;  
Number of vehicles;  
Aggregate delay time;  
Optimization;  
Interior point algorithm.

*Copyright © 2019 International Journals of Multidisciplinary  
Research Academy. All rights reserved.*

---

### Author correspondence:

First author

Yogeswary Raviraj,  
Department of Mathematical Sciences,  
Faculty of Applied Sciences,  
South Eastern University of Sri Lanka,  
Sri Lanka.

Second author

W.B.Daundasekera  
Department of Mathematics,  
Faculty of Science,  
University of Peradeniya,  
Sri Lanka.

---

\*Department of Mathematical Sciences, Faculty of Applied Sciences, South Eastern University of Sri Lanka, Sri Lanka

\*\*Department of Mathematics, Faculty of Science, University of Peradeniya, Sri Lanka

## 1. INTRODUCTION

The monitoring and controlling of traffic at a road is a major problem in many countries, because number of vehicles in the roads increases daily that leads to traffic congestion problem. Traffic congestion wastes a huge amount of countries' national income for fuel and creates traffic – related environmental and socio economic problems. Improperly managed traffic intersections contribute a lot to this traffic congestion.

Some existing optimization models to overcome the traffic control problem at a road intersection are: Discrete minimal delay model [1], [2], Microprocessor Optimized Vehicle Actuation (MOVA) [3], [4], Staged-based optimization [5], Webster's Model [6], [7] and HCM 2000 model [8].

Traffic-signal is the most acceptable method of controlling traffic in busy intersections. Delay [1] and the number of vehicles waiting are the important measures of effectiveness for signalized intersections. This research considers the oversaturation level at road intersections, where the intersections considered have four signals for a particular minimum cycle time, and the green time is allocated for all four signals.

Our objective of this research is to formulate a mathematical model to minimize aggregate delay [9] time of vehicles and the total number of vehicles which are waiting in the lanes of a road intersection due to red signal by allocating sufficient amount of green time for each signal and cycle time. To maintain the feasibility, the upper bound for cycle time and number of vehicles waiting are restricted. The real time data is calculated by using cameras [10] installed in every lane in the road intersection. This model is solved by interior point algorithm coded in MATLAB environment [11].

## 2. PROPOSED METHODOLOGY

In this part we consider a signalized isolated intersection with four lanes namely Lane  $j$ ,  $j = 1, 2, 3, 4$ . We divide this intersection into four stages: in Stage 1, the green signal will be on for Lane 1, where the vehicles which are waiting at the Lane 1 can move into other three lanes through the intersection as shown in the figure below:

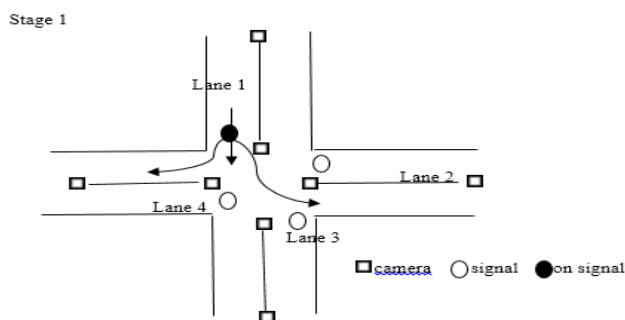

**Figure 1:** Green signal for Lane 1.

Also, when the green signal is on for another lane the vehicles waiting in that lane will proceed to other lanes in a similar manner as described above in the Figure 1.

### 2.1. Formulation of the Model

The notations used in this model are:

Lane  $j$ :  $j^{\text{th}}$  lane at the road intersection,  $j=1, 2, 3, 4$ ,

$N_j(k)$ : Number of vehicles in Lane  $j$  at cycle  $k$ ,

$Ig_i(k)$ : inter green time for the signal for Lane  $i$ ,  $i=1, 2, 3, 4$  at cycle  $k$ ,

$W_j$ : Weighting parameter of Lane  $j$ ,  $j=1, 2, 3, 4$ ,

$t_i(k)$ : Allocated green time for the signal for Lane  $i$ ,  $i=1, 2, 3, 4$  at cycle  $k$ ,

$(t_j(k))_{\min}$ : Minimum green time for the signal for Lane  $j$ ,  $j=1, 2, 3, 4$ , at cycle  $k$ ,

$(t_j(k))_{\max}$ : Maximum green time for the signal for Lane  $j$ ,  $j=1, 2, 3, 4$ , at cycle  $k$ ,

$C(k)$ : Cycle time at cycle  $k$ ,

$CT_{min}$ : Minimum cycle time,

$CT_{max}$ : Maximum cycle time,

$f_j(k)$ : Incoming flow rate of vehicles for the Lane  $j, j=1, 2, 3, 4$  during maximum cycle time at cycle  $k$ ,

$f_j^{(t_i(k)+I g_i(k))}$ : Incoming flow rate of vehicles for the Lane  $j, j=1, 2, 3, 4$  during allocated green time and inter green time for the signal for Lane  $i, i=1, 2, 3, 4$  at cycle  $k$ ,

Here,  $f_j^{(t_i(k)+I g_i(k))} = \frac{f_j(k) (t_i(k)+I g_i(k))}{CT_{max}}$ .

$s_j(k)$ : Outgoing flow rate of vehicles for the Lane  $j, j=1, 2, 3, 4$  at cycle  $k$ ,

$D_j(k + 1)$ : Aggregate delay time of vehicles in cycle  $k$  at Lane  $j, j=1, 2, 3, 4$ ,

$NT(k)$ : Total number of vehicles at the intersection at cycle  $k$ .

The number of vehicles at oversaturated situation and aggregate delay time of four stages are illustrated (modified from [12]) in the figure below:

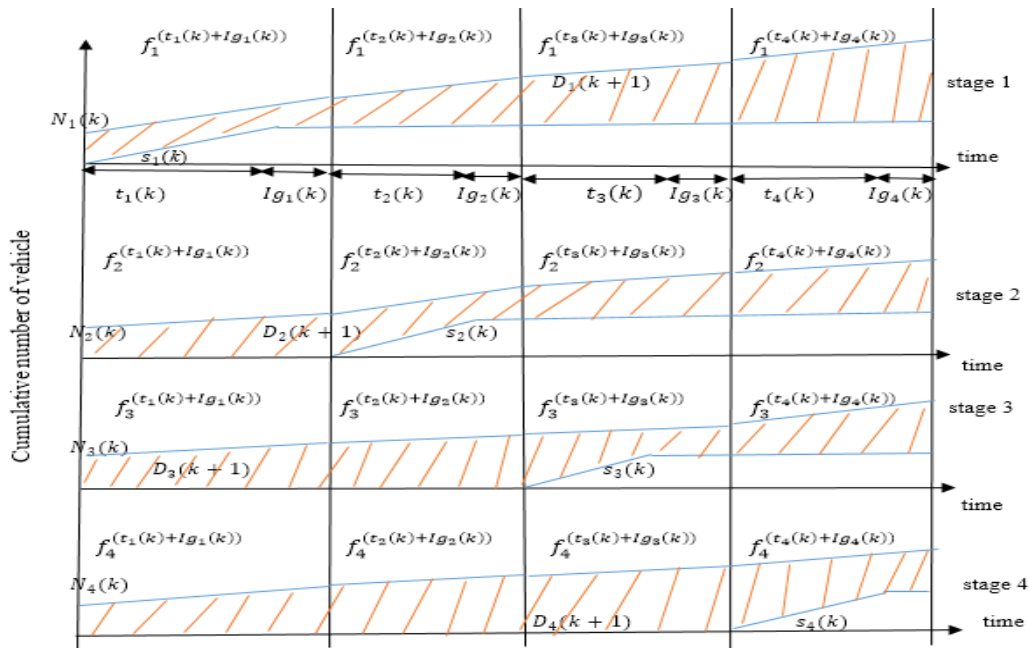

**Figure 2:** Number of vehicles and delay of four stages at oversaturation situation.

The oversaturation condition for a particular lane is that the outgoing number of vehicles during green signal should be strictly less than the total of the number of existing vehicles at the beginning of the cycle and incoming number of vehicles during the previous stages green signal time and inter green time.

The inequalities [13] which satisfy the oversaturation condition at each stage are given below:

$$s_1(k)t_1(k) < N_1(k) + f_1^{(t_1(k)+I g_1(k))} t_1(k), \tag{1}$$

$$s_2(k)t_2(k) < N_2(k) + f_2^{(t_1(k)+I g_1(k))} (t_1(k) + I g_1(k)) + f_2^{(t_2(k)+I g_2(k))} t_2(k), \tag{2}$$

$$s_3(k)t_3(k) < N_3(k) + f_3^{(t_1(k)+I g_1(k))} (t_1(k) + I g_1(k)) + f_3^{(t_2(k)+I g_2(k))} (t_2(k) + I g_2(k)) + f_3^{(t_3(k)+I g_3(k))} t_3(k), \tag{3}$$

$$s_4(k)t_4(k) < N_4(k) + f_4^{(t_1(k)+I g_1(k))} (t_1(k) + I g_1(k)) + f_4^{(t_2(k)+I g_2(k))} (t_2(k) + I g_2(k)) + f_4^{(t_3(k)+I g_3(k))} (t_3(k) + I g_3(k)) + f_4^{(t_4(k)+I g_4(k))} t_4(k), \tag{4}$$

where  $f_j^{(t_i(k)+I g_i(k))} = \frac{f_j(k) (t_i(k)+I g_i(k))}{CT_{max}}$ ,  $j = 1,2,3,4$ ,  $i = 1,2,3,4$ .

The aggregate delay time at each stage of the model is illustrated below:

In Stage 1, the aggregate delay time of vehicles for  $(k+1)^{\text{th}}$  cycle (aggregate delay time of vehicles at the end of  $k^{\text{th}}$  cycle) is calculated by the aggregate delay time of vehicles in the Lane 1 during green signal is on and after the green signal is off which is represented by the shaded area of Stage 1 in Figure 2.

In Stage 2, the aggregate delay time of vehicles for  $(k+1)^{\text{th}}$  cycle (aggregate delay time of vehicles at the end of  $k^{\text{th}}$  cycle) is calculated by the aggregate delay time of vehicles in the Lane 2 before green signal is on, during green signal is on and after the green signal is off which is represented by the shaded area of Stage 2 in Figure 2. Similarly for the other two stages, the total delay time for  $(k+1)^{\text{th}}$  cycle is illustrated in the Figure 2.

Aggregate delay time for vehicles at each stage at the end of cycle  $k$  is calculated from the area of the shaded region in the Figure 2 as given below:

$$\begin{aligned}
 D_1(k+1) &= N_1(k)(t_1(k) + Ig_1(k)) + \frac{1}{2}(t_1(k) + Ig_1(k))^2 f_1^{(t_1(k)+Ig_1(k))} \\
 &+ \left( N_1(k) + f_1^{(t_1(k)+Ig_1(k))}(t_1(k) + Ig_1(k)) \right) (t_2(k) + Ig_2(k)) \\
 &+ \frac{1}{2}(t_2(k) + Ig_2(k))^2 f_1^{(t_2(k)+Ig_2(k))} \\
 &\quad + \left( N_1(k) + f_1^{(t_1(k)+Ig_1(k))}(t_1(k) + Ig_1(k)) \right. \\
 &\quad \left. + f_1^{(t_2(k)+Ig_2(k))}(t_2(k) + Ig_2(k)) \right) (t_3(k) + Ig_3(k)) \\
 &\quad + \frac{1}{2}(t_3(k) + Ig_3(k))^2 f_1^{(t_3(k)+Ig_3(k))} \\
 &\quad + \left( N_1(k) + f_1^{(t_1(k)+Ig_1(k))}(t_1(k) + Ig_1(k)) + f_1^{(t_2(k)+Ig_2(k))}(t_2(k) + Ig_2(k)) \right. \\
 &\quad \left. + f_1^{(t_3(k)+Ig_3(k))}(t_3(k) + Ig_3(k)) \right) \\
 &\quad (t_4(k) + Ig_4(k)) + \frac{1}{2}(t_4(k) + Ig_4(k))^2 f_1^{(t_4(k)+Ig_4(k))} - \frac{1}{2}s_1(k)(t_1(k))^2 \\
 &- s_1(k)t_1(k)(Ig_1(k) + t_2(k) + Ig_2(k) + t_3(k) + Ig_3(k) + t_4(k) + Ig_4(k)), \tag{5}
 \end{aligned}$$

$$\begin{aligned}
 D_2(k+1) &= N_2(k)(t_1(k) + Ig_1(k)) + \frac{1}{2}(t_1(k) + Ig_1(k))^2 f_2^{(t_1(k)+Ig_1(k))} + \left( N_2(k) + \right. \\
 &\left. f_2^{(t_1(k)+Ig_1(k))}(t_1(k) + Ig_1(k)) \right) (t_2(k) + Ig_2(k)) + \frac{1}{2}(t_2(k) + Ig_2(k))^2 f_2^{(t_2(k)+Ig_2(k))} + \\
 &\left( N_2(k) + f_2^{(t_1(k)+Ig_1(k))}(t_1(k) + Ig_1(k)) + f_2^{(t_2(k)+Ig_2(k))}(t_2(k) + Ig_2(k)) \right) (t_3(k) + \\
 &Ig_3(k)) + \frac{1}{2}(t_3(k) + Ig_3(k))^2 f_2^{(t_3(k)+Ig_3(k))} + \left( N_2(k) + f_2^{(t_1(k)+Ig_1(k))}(t_1(k) + Ig_1(k)) + \right. \\
 &\left. f_2^{(t_2(k)+Ig_2(k))}(t_2(k) + Ig_2(k)) + f_2^{(t_3(k)+Ig_3(k))}(t_3(k) + Ig_3(k)) \right) (t_4(k) + Ig_4(k)) + \\
 &\frac{1}{2}(t_4(k) + Ig_4(k))^2 f_2^{(t_4(k)+Ig_4(k))} - \frac{1}{2}s_2(k)(t_2(k))^2 - s_2(k)t_2(k)(Ig_2(k) + \\
 &t_3(k) + Ig_3(k) + t_4(k) + Ig_4(k)), \tag{6}
 \end{aligned}$$

$$\begin{aligned}
 D_3(k+1) &= N_3(k)(t_1(k) + Ig_1(k)) + \frac{1}{2}(t_1(k) + Ig_1(k))^2 f_3^{(t_1(k)+Ig_1(k))} + \left( N_3(k) + \right. \\
 &\left. f_3^{(t_1(k)+Ig_1(k))}(t_1(k) + Ig_1(k)) \right) (t_2(k) + Ig_2(k)) + \frac{1}{2}(t_2(k) + Ig_2(k))^2 f_1^{(t_2(k)+Ig_2(k))} +
 \end{aligned}$$

$$\begin{aligned} & \left( N_3(k) + f_3^{(t_1(k)+I_{g_1}(k))} (t_1(k) + I_{g_1}(k)) + f_3^{(t_2(k)+I_{g_2}(k))} (t_2(k) + I_{g_2}(k)) \right) (t_3(k) + \\ & I_{g_3}(k)) + \frac{1}{2} (t_3(k) + I_{g_3}(k))^2 f_3^{(t_3(k)+I_{g_3}(k))} + \left( N_3(k) + f_3^{(t_1(k)+I_{g_1}(k))} (t_1(k) + I_{g_1}(k)) + \right. \\ & \left. f_3^{(t_2(k)+I_{g_2}(k))} (t_2(k) + I_{g_2}(k)) + f_3^{(t_3(k)+I_{g_3}(k))} (t_3(k) + I_{g_3}(k)) \right) (t_4(k) + I_{g_4}(k)) + \\ & \frac{1}{2} (t_4(k) + I_{g_4}(k))^2 f_3^{(t_4(k)+I_{g_4}(k))} - \frac{1}{2} s_3(k) (t_3(k))^2 - s_3(k) t_3(k) (I_{g_3}(k) + \\ & t_4(k) + I_{g_4}(k)), \end{aligned} \quad (7)$$

$$\begin{aligned} D_4(k+1) = & N_4(k) (t_1(k) + I_{g_1}(k)) + \frac{1}{2} (t_1(k) + I_{g_1}(k))^2 f_4^{(t_1(k)+I_{g_1}(k))} + \left( N_4(k) + \right. \\ & \left. f_4^{(t_1(k)+I_{g_1}(k))} (t_1(k) + I_{g_1}(k)) \right) (t_2(k) + I_{g_2}(k)) + \frac{1}{2} (t_2(k) + I_{g_2}(k))^2 f_4^{(t_2(k)+I_{g_2}(k))} + \\ & \left( N_4(k) + f_4^{(t_1(k)+I_{g_1}(k))} (t_1(k) + I_{g_1}(k)) + f_4^{(t_2(k)+I_{g_2}(k))} (t_2(k) + I_{g_2}(k)) \right) (t_3(k) + \\ & I_{g_3}(k)) + \frac{1}{2} (t_3(k) + I_{g_3}(k))^2 f_4^{(t_3(k)+I_{g_3}(k))} + \left( N_4(k) + f_4^{(t_1(k)+I_{g_1}(k))} (t_1(k) + I_{g_1}(k)) + \right. \\ & \left. f_4^{(t_2(k)+I_{g_2}(k))} (t_2(k) + I_{g_2}(k)) + f_4^{(t_3(k)+I_{g_3}(k))} (t_3(k) + I_{g_3}(k)) \right) (t_4(k) + I_{g_4}(k)) + \\ & \frac{1}{2} (t_4(k) + I_{g_4}(k))^2 f_4^{(t_4(k)+I_{g_4}(k))} - \frac{1}{2} s_4(k) (t_4(k))^2 - s_4(k) t_4(k) I_{g_4}(k), \end{aligned} \quad (8)$$

where  $f_j^{(t_i(k)+I_{g_i}(k))} = \frac{f_j(k) (t_i(k)+I_{g_i}(k))}{CT_{max}}$ ,  $j = 1,2,3,4$ ,  $i = 1,2,3,4$ .

The numbers of vehicles in four lanes at the end of the cycle  $k$  is given by the following four equations respectively. The equations are modified from [14]. First equation represents number of vehicles in Lane 1 at the end of cycle  $k$  (or beginning of cycle  $k+1$ ) which is equivalent to the total of the number of vehicles waiting at the beginning of cycle  $k$  (from camera readings), incoming number of vehicles into the Lane 1 during green signal time, inter signal green time and red signal time and excluding outgoing number of vehicles during green signal time for the Lane 1. Similarly, the number of vehicles in Lane 2, Lane 3 and Lane 4, at the end of cycle  $k$  (for cycle  $k+1$ ) are given by the remaining three equations respectively:

$$\begin{aligned} N_1(k+1) = & N_1(k) + (t_1(k) + I_{g_1}(k)) f_1^{(t_1(k)+I_{g_1}(k))} - (t_1(k)) s_1(k) + (t_2(k) + \\ & I_{g_2}(k)) f_1^{(t_2(k)+I_{g_2}(k))} + (t_3(k) + I_{g_3}(k)) f_1^{(t_3(k)+I_{g_3}(k))} + (t_4(k) + \\ & I_{g_4}(k)) f_1^{(t_4(k)+I_{g_4}(k))} \end{aligned} \quad (9)$$

$$\begin{aligned} N_2(k+1) = & N_2(k) + (t_2(k) + I_{g_2}(k)) f_2^{(t_2(k)+I_{g_2}(k))} - (t_2(k)) s_2(k) + (t_1(k) + \\ & I_{g_1}(k)) f_2^{(t_1(k)+I_{g_1}(k))} + (t_3(k) + I_{g_3}(k)) f_2^{(t_3(k)+I_{g_3}(k))} + (t_4(k) + \\ & I_{g_4}(k)) f_2^{(t_4(k)+I_{g_4}(k))} \end{aligned} \quad (10)$$

$$\begin{aligned} N_3(k+1) = & N_3(k) + (t_3(k) + I_{g_3}(k)) f_3^{(t_3(k)+I_{g_3}(k))} - (t_3(k)) s_3(k) + (t_1(k) + \\ & I_{g_1}(k)) f_3^{(t_1(k)+I_{g_1}(k))} + (t_2(k) + I_{g_2}(k)) f_3^{(t_2(k)+I_{g_2}(k))} + (t_4(k) + \\ & I_{g_4}(k)) f_3^{(t_4(k)+I_{g_4}(k))} \end{aligned} \quad (11)$$

$$\begin{aligned} N_4(k+1) = & N_4(k) + (t_4(k) + I_{g_4}(k)) f_4^{(t_4(k)+I_{g_4}(k))} - (t_4(k)) s_4(k) + (t_1(k) + \\ & I_{g_1}(k)) f_4^{(t_1(k)+I_{g_1}(k))} + (t_2(k) + I_{g_2}(k)) f_4^{(t_2(k)+I_{g_2}(k))} + (t_3(k) + \\ & I_{g_3}(k)) f_4^{(t_3(k)+I_{g_3}(k))} \end{aligned} \quad (12)$$

where

$$f_j^{(t_i(k)+I g_i(k))} = \frac{f_j(k) (t_i(k) + I g_i(k))}{CT_{max}}, \quad j = 1,2,3,4, \quad i = 1,2,3,4.$$

Lower and upper bounds of green signal time are given by

$$(t_i(k))_{min} \leq t_i(k) \leq (t_i(k))_{max}, \quad i = 1,2,3,4 \quad (13)$$

Cycle time of cycle  $k$  is given by the total green signal time and total inter green signal time:

$$(t_1(k) + I g_1(k)) + (t_2(k) + I g_2(k)) + (t_3(k) + I g_3(k)) + (t_4(k) + I g_4(k)) = C(k) \quad (14)$$

Lower and upper bounds of cycle time are given by

$$CT_{min} \leq C(k) \leq CT_{max} \quad (15)$$

The incoming number of vehicles into the lane during a cycle time is less than or equal to the outgoing number of vehicles from the lane during green signal time for that lane is also considered as a condition. Each of the following four inequalities represents that condition for each of the respective four lanes during cycle  $k$ :

$$f_1^{(t_1(k)+I g_1(k))} (t_1(k) + I g_1(k)) + f_1^{(t_2(k)+I g_2(k))} (t_2(k) + I g_2(k)) + f_1^{(t_3(k)+I g_3(k))} (t_3(k) + I g_3(k)) + f_1^{(t_4(k)+I g_4(k))} (t_4(k) + I g_4(k)) \leq s_1(k) t_1(k), \quad (16)$$

$$f_2^{(t_1(k)+I g_1(k))} (t_1(k) + I g_1(k)) + f_2^{(t_2(k)+I g_2(k))} (t_2(k) + I g_2(k)) + f_2^{(t_3(k)+I g_3(k))} (t_3(k) + I g_3(k)) + f_2^{(t_4(k)+I g_4(k))} (t_4(k) + I g_4(k)) \leq s_2(k) t_2(k), \quad (17)$$

$$f_3^{(t_1(k)+I g_1(k))} (t_1(k) + I g_1(k)) + f_3^{(t_2(k)+I g_2(k))} (t_2(k) + I g_2(k)) + f_3^{(t_3(k)+I g_3(k))} (t_3(k) + I g_3(k)) + f_3^{(t_4(k)+I g_4(k))} (t_4(k) + I g_4(k)) \leq s_3(k) t_3(k), \quad (18)$$

$$f_4^{(t_1(k)+I g_1(k))} (t_1(k) + I g_1(k)) + f_4^{(t_2(k)+I g_2(k))} (t_2(k) + I g_2(k)) + f_4^{(t_3(k)+I g_3(k))} (t_3(k) + I g_3(k)) + f_4^{(t_4(k)+I g_4(k))} (t_4(k) + I g_4(k)) \leq s_4(k) t_4(k) \quad (19)$$

where

$$f_j^{(t_i(k)+I g_i(k))} = \frac{f_j(k) (t_i(k) + I g_i(k))}{CT_{max}}, \quad j = 1,2,3,4, \quad i = 1,2,3,4.$$

A special oversaturation condition is defined as  $\alpha$  times the number of outgoing vehicles during green signal time in a lane at a given cycle is less than the number of vehicles in that lane at the end of that cycle. This condition satisfies the oversaturation conditions given in equations (1), (2), (3) and (4), along with above conditions given in inequalities (16), (17), (18) and (19). The following set of inequalities represents the special oversaturation condition:

$\alpha s_j(k) t_j(k) \leq N_j(k+1)$ ,  $j = 1,2,3,4$  and  $\alpha$  is a positive number. Upper bound of  $\alpha$  depends on the other variable values of the problem.

When the value of  $\alpha$  decreases the number of waiting vehicles at the end of the final cycle will decrease and number of cycles to converge to final cycle will increase. In this model two better cases are considered.

Case I ( $\alpha = 2$ )

The following set of four inequalities represent the special oversaturation conditions during cycle  $k$  for the Lane 1, Lane 2, Lane 3 and Lane 4 respectively:

$$2s_j(k) t_j(k) \leq N_j(k+1), \quad j = 1,2,3,4 \quad (20)$$

Case II ( $\alpha = 1$ )

The following set of four in equalities represent the special oversaturation conditions during cycle  $k$  for the Lane 1, Lane 2, Lane 3 and Lane 4 respectively:

$$s_j(k) t_j(k) \leq N_j(k+1), \quad j = 1,2,3,4 \quad (21)$$

## 2.2 Flow Chart of the Model and the Method of Solution

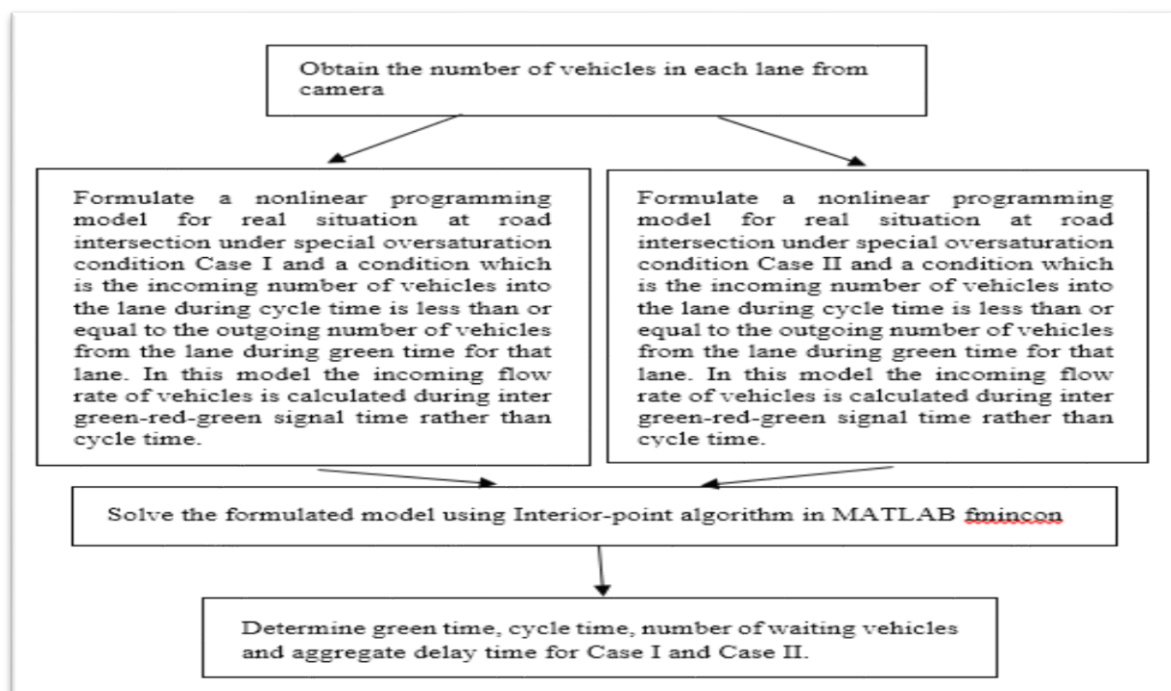

**Figure 3:** Flow chart for the model and the method of solution

## 3. RESEARCH METHODOLOGY

Two nonlinear programming models are developed under Case I and Case II respectively. Objectives of the nonlinear programming problem model under Case I and nonlinear programming problem model under Case II are to minimize the number of waiting vehicles and aggregate delay times of vehicles by optimizing total number of vehicles at the intersection subject to the Case I oversaturation and Case II oversaturation condition respectively, and the delay, additional condition and some constraints related to the traffic signal control problem, which are described above, are combined into the models formulation and is illustrated in sections 3.1 and 3.2 respectively to calculate the duration of the green signal time at the beginning of the cycle  $k$ :

In both models:

- The cycle time is equal to the sum of the total green signal time and total inter green time. Each green time value has a minimum value  $((g_{ij}(k))_{min})$  and a maximum value  $((g_{ij}(k))_{max})$  which are fixed for a cycle.
- In order to maintain the feasibility, the sum of the total minimum green signal time values and inter green signal time values are assumed to be greater than or equal to  $(CT_i)_{min}, i = 1, 2$  and also, the sum of the total maximum green signal time values and inter green signal time values are assumed to be less than or equal to  $(CT_i)_{max}, i = 1, 2$ .
- The objective function consists of waiting parameters  $W_j, j = 1, 2, 3, 4$  assigned to each lane at intersection. The default value of  $W_j, j = 1, 2, 3, 4$  is assigned to 1. The objective function can be optimized by selecting different waiting parameters  $W_j$  according to different criteria: lane priority, emergency vehicle passing etc.
- To optimize green time for each signal we apply interior point algorithm implemented in the MATLAB optimization toolbox for the above nonlinear programming problem.

### 3.1 Nonlinear programming problem model under Case I

$$\text{Minimize } Z = \sum_{j=1}^4 W_j N_j(k+1)$$

Subject to

Equations (9), (10), (11), (12), (13), (14), (15), (16), (17), (18), (19) and (20),

$$D_j(k+1) \geq 0, \quad j = 1, 2, 3, 4,$$

### 3.2 Nonlinear programming problem model under Case II

Minimize  $Z = \sum_{j=1}^4 W_j N_j(k + 1)$

Subject to

Equations (9), (10), (11), (12), (13), (14), (15), (16), (17), (18), (19) and (21),

$D_j(k + 1) \geq 0, \quad j = 1,2,3,4,$

### 3.3 Hypothetical data set

One intersection is considered to discuss these proposed models. Hypothetical data set is applied to find optimum solution of the nonlinear programming problem model under each Case I and Case II.

In each lane the distance between upstream camera and downstream camera is 150 m. If we assume that the average length of a small vehicle is approximately 5 m, then the maximum number of vehicles in a lane within 150 m is 30.

Incoming flow rates of vehicles for the lanes are fixed over the cycles given by  $f_1=0.1$  vehicles /sec.,  $f_2 =0.18$ vehicles/sec.,  $f_3=0.1$  vehicles/sec.,  $f_4=0.18$  vehicles/sec.

Outgoing flow rates of vehicles for the lanes are fixed over the cycles given by  $s_i= 0.4$  vehicles/sec.,  $i = 1, 2, 3, 4.$

Inter green signal time is given by  $Ig_j=3$  sec.,  $j=1, 2, 3, 4.$

Maximum cycle time is given by  $CT_{max}=90$  sec.

## 4. RESULTS AND DISCUSSION

### 4.1 Results and discussion under Case I

Simulation results and corresponding graphs are given in the following Table 1, Figure 4 and Figure 5 for scenario 1:

From camera readings:  $N_1(1) = 16, N_2(1) = 27, N_3(1) = 19, N_4(1) = 22$

Phase sequence order (signal order): Lane 2 signal, Lane 4 signal, Lane 3 signal, Lane 1 signal (corresponds to decreasing order of number of vehicles in lanes)

**Table 1:** Cycles and the optimum feasible results under Case I for scenario 1

Cycle $k$	Number of vehicles in lanes and total of that at the beginning of the cycle $N_j(k)$ [NT(k)] $j = 1,2,3,4$	Green signal time (sec.) $t_j(k), j = 1,2,3,4$	Cycle time (sec.) $C(k)$	Aggregate delay time of vehicles in lanes at the end of the cycle (sec.) $D_j(k + 1), j = 1,2,3,4$	Number of vehicles in lanes at the end of the cycle $N_j(k + 1), j = 1,2,3,4$
1	16 27 19 22 [84]	15 23 17 21	88	1019, 2007, 1525, 1673	12 22 14 18
2	12 22 14 18 [66]	11 20 13 17	73	634, 1312, 923, 1011	09 17 10 14
3	09 17 10 14 [50]	08 15 09 13	57	369, 785, 511, 552	07 13 07 10
4	07 13 07 10 [37]	06 11 06 09	44	222, 464, 277, 296	05 10 05 07
5	05 10 05 07 [27]	04 08 04 06	34	124, 277, 153, 162	04 07 04 05
6	04 07 04 05 [20]	03 06 03 04	28	83, 156, 101, 108	03 05 03 04
7	03 05 03 04 [15]	02 04 02 03	23	53, 92, 63, 66	02 04 02 03
8	02 04 02 03 [11]	01 03 01 02	19	32, 62, 36, 36	02 03 02 02
9	02 03 02 02 [09]	01 02 01 01	17	28, 43, 32, 33	02 02 02 02
10	02 02 02 02 [08]	01 01 01 01	16	26, 28, 30, 31	02 02 02 02
11	02 02 02 02 [08]	01 01 01 01	16	26, 28, 30, 31	02 02 02 02

In the Table 1 given above, the results of cycle 10 and cycle 11 are the same. If this process continues into more cycles, the results will be the same as the results of cycle 10. Because of oversaturation situation, some vehicles are still waiting in each lane in the last cycle (cycle 10).



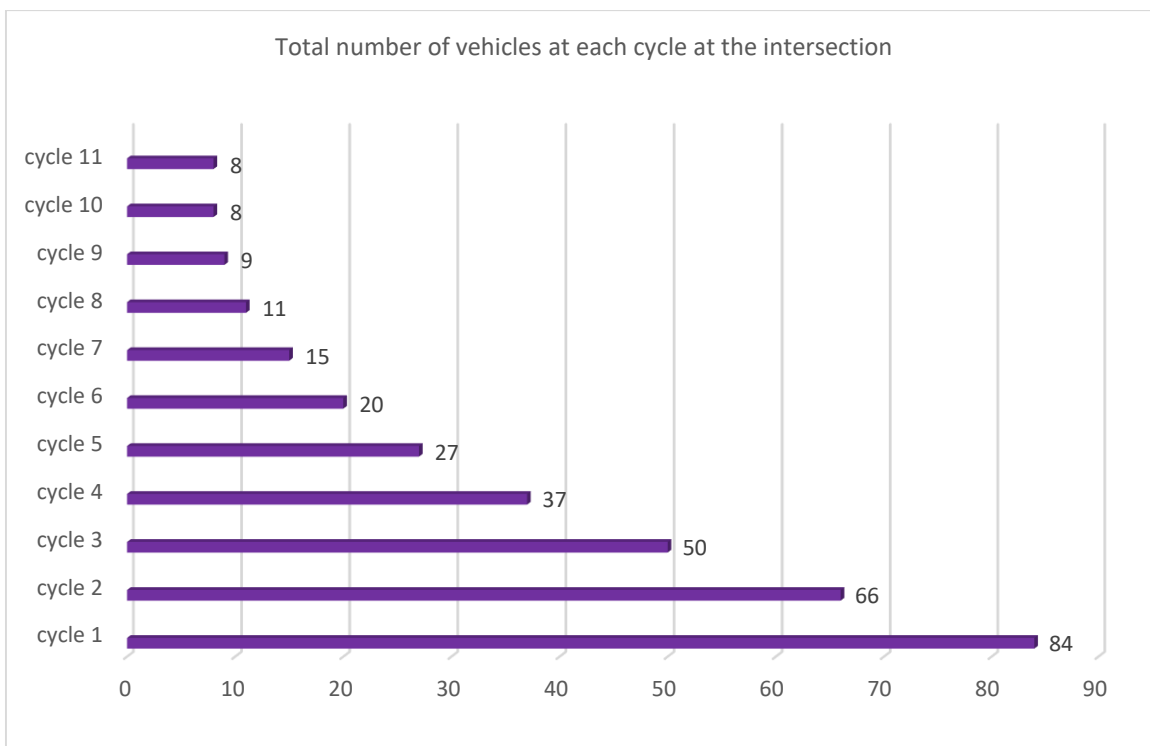

**Figure 4:** Total number of vehicles at each cycle in Lane 1, Lane 2, Lane 3 and Lane 4 under Case I for scenario 1

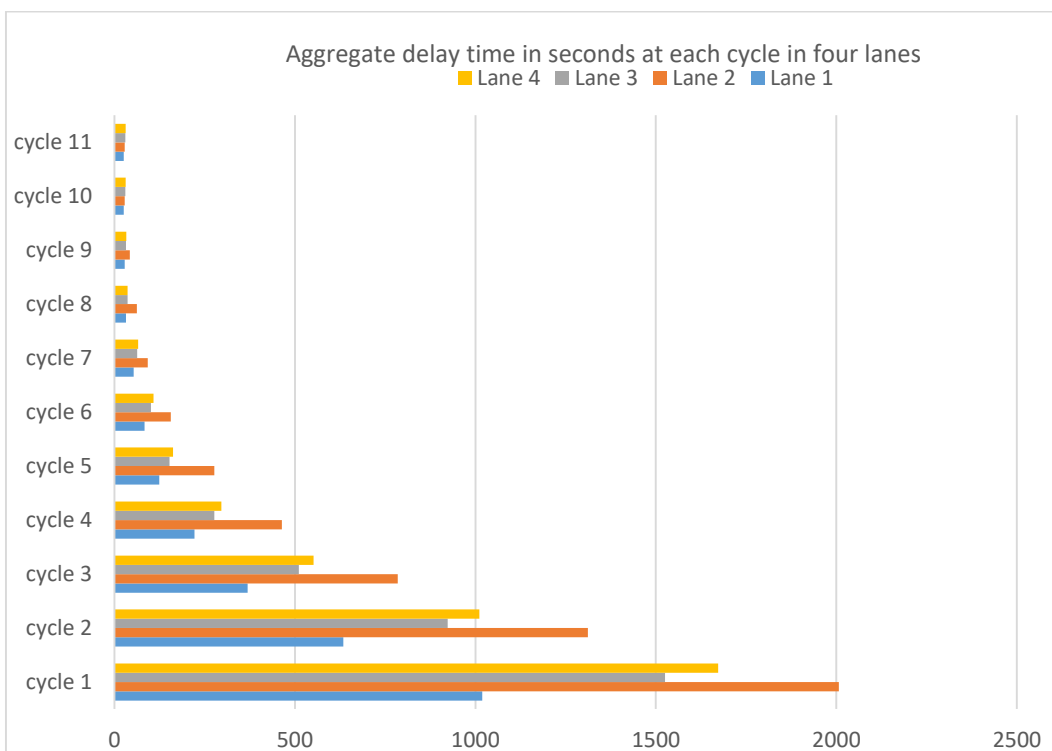

**Figure 5:** Aggregate delay time at each cycle for Lane 1, Lane 2, Lane 3 and Lane 4 under Case I for scenario 1

Simulation results and corresponding graphs are given in the Table 2, Figure 6 and Figure 7 for scenario 2 below:

From camera readings:  $N_1(1) = 09$ ,  $N_2(1) = 10$ ,  $N_3(1) = 07$ ,  $N_4(1) = 14$

Phase sequence order (signal order): Lane 4 signal, Lane 2 signal, Lane 1 signal, Lane 3 signal (corresponds to decreasing order of number of vehicles in lanes)

**Table 2:** Cycles and the optimum feasible results under Case I for scenario 2

Cycle $k$	Number of vehicles in lanes and total of that at the beginning of the cycle $N_j(k)$ [NT( $k$ )] $j = 1,2,3,4$	Green signal time (sec.) $t_j(k), j = 1,2,3,4$	Cycle time (sec.) $C(k)$	Aggregate delay time at the end of the cycle (sec.) $D_j(k + 1), j = 1,2,3,4$	Number of vehicles in lanes at the end of the cycle $N_j(k + 1), j = 1,2,3,4$
1	09 10 07 14 [40]	08 09 06 12	47	299, 382, 293, 303	06 08 05 10
2	06 08 05 10 [29]	05 07 04 08	36	155, 231, 161, 165	04 06 04 07
3	04 06 04 07 [21]	03 05 03 06	29	86, 139, 103, 106	03 04 03 05
4	03 04 03 05 [15]	02 03 02 04	23	53, 75, 62, 63	02 03 02 04
5	02 03 02 04 [11]	01 02 01 03	19	32, 47, 35, 34	02 02 02 03
6	02 02 02 03 [09]	01 01 01 02	17	28, 30, 31, 32	02 02 02 02
7	02 02 02 02 [08]	01 01 01 01	16	26, 28, 30, 31	02 02 02 02
8	02 02 02 02 [08]	01 01 01 01	16	26, 28, 30, 31	02 02 02 02

In Table 2 given above, the results of cycle 7 and cycle 8 are the same. If this process continues more cycles, the results will be same as the results of cycle 7. Because of oversaturation situation, some vehicles are still waiting in each lane in the final cycle (cycle 7).

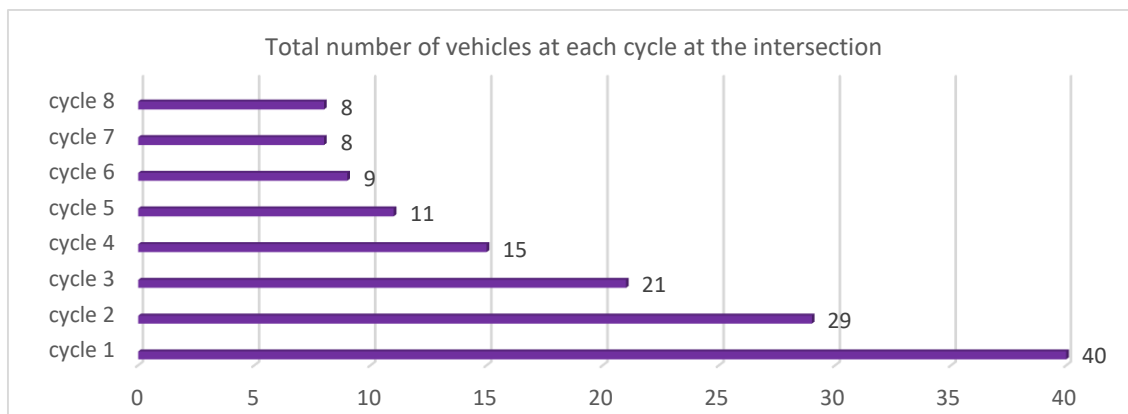

**Figure 6:** Total number of vehicles at each cycle in Lane 1, Lane 2, Lane 3 and Lane 4 under Case I for scenario 2

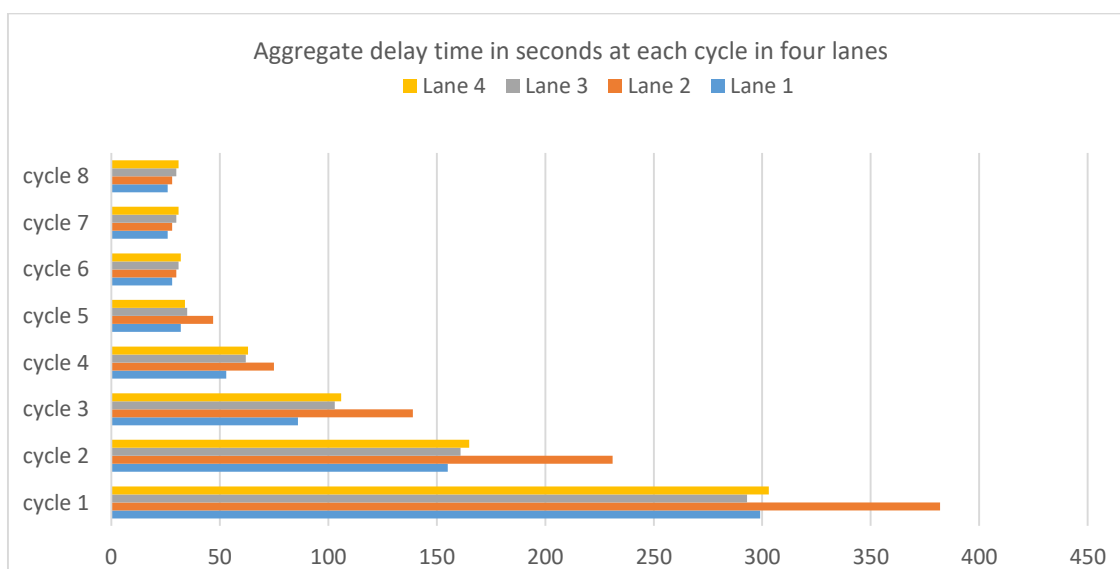

**Figure 7:** Aggregate delay time at each cycle for Lane 1, Lane 2, Lane 3 and Lane 4 under Case I for scenario 2

**4.2 Results and discussion under Case II**

Simulation results and corresponding graphs are given in the following Table 3, Figure 8 and Figure 9 for scenario 1:

From camera readings:  $N_1(1) = 16, N_2(1) = 27, N_3(1) = 19, N_4(1) = 22$

Phase sequence order (signal order): Lane 2 signal, Lane 4 signal, Lane 3 signal, Lane 1 signal (corresponds to decreasing order of number of vehicles in lanes)

**Table 3:** Cycles and the optimum feasible results under Case II for scenario 1

Cycle $k$	Number of vehicles in lanes and total of that at the beginning of the cycle $N_j(k)$ [NT(k)] $j = 1,2,3,4$	Green signal time (sec.) $t_j(k), j = 1,2,3,4$	Cycle time (sec.) $C(k)$	Aggregate delay time of vehicles in lanes at the end of the cycle (sec.) $D_j(k+1), j = 1,2,3,4$	Number of vehicles in lanes at the end of the cycle $N_j(k+1), j = 1,2,3,4$
1	16 27 19 22 [84]	19 19 19 19	88	906, 2117, 1504, 1691	11 23 14 18
2	11 23 14 18 [66]	16 20 20 20	88	548, 1718, 1036, 1240	07 19 08 14
3	07 19 08 14 [48]	11 29 13 22	87	351, 1155, 617, 698	05 12 05 09
4	05 12 05 09 [31]	07 17 07 13	56	159, 464, 243, 263	03 07 03 06
5	03 07 03 06 [19]	04 09 04 08	37	62, 180, 93, 97	02 04 02 04
6	02 04 02 04 [12]	02 05 02 05	26	34, 71, 45, 44	01 02 01 02
7	01 02 01 02 [06]	01 02 01 02	18	12, 27, 15, 16	01 01 01 01
8	01 01 01 01 [04]	01 01 01 01	16	10, 12, 14, 15	01 01 01 01
9	01 01 01 01 [04]	01 01 01 01	16	10, 12, 14, 15	01 01 01 01

In the Table 3 given above, the results of cycle 8 and cycle 9 are the same. If this process continues into more cycles, the results will be the same as the results of cycle 8. Because of oversaturation situation, some vehicles are still waiting in each lane in the last cycle (cycle 8).

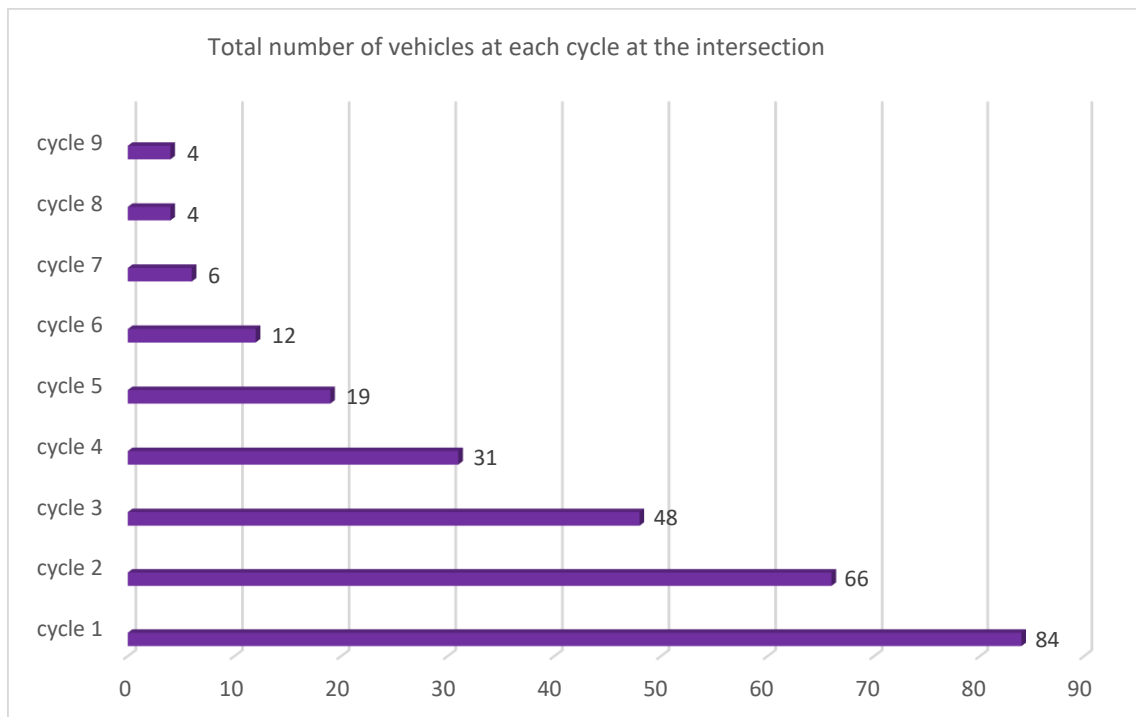

**Figure 8:** Total number of vehicles at each cycle in Lane 1, Lane 2, Lane 3 and Lane 4 under Case II for scenario 1

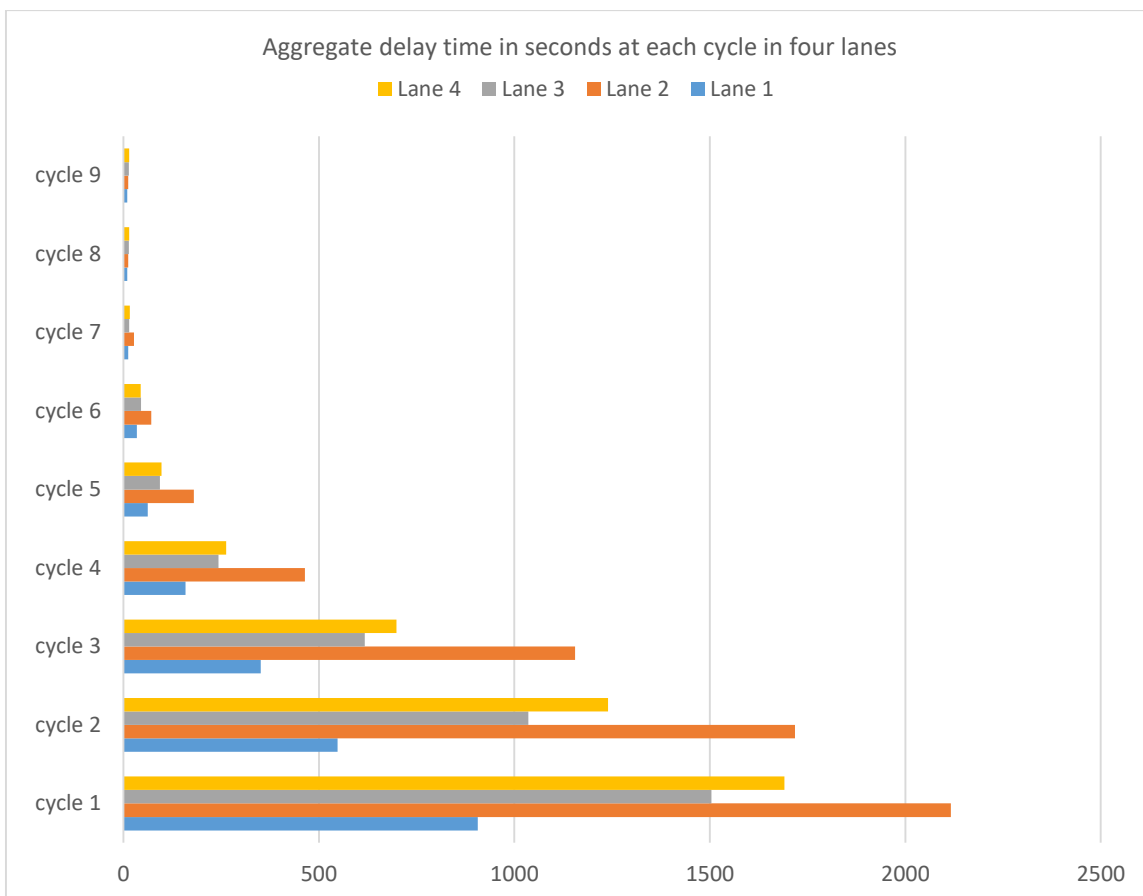

**Figure 9:** Aggregate delay time at each cycle for Lane 1, Lane 2, Lane 3 and Lane 4 under Case II for scenario 1

Simulation results and corresponding graphs are given in Table 4, Figure 10 and Figure 11 for scenario 2 below:

From camera readings:  $N_1(1) = 09, N_2(1) = 10, N_3(1) = 07, N_4(1) = 14$

Phase sequence order (signal order): Lane 4 signal, Lane 2 signal, Lane 1 signal, Lane 3 signal (corresponds to decreasing order of number of vehicles in lanes)

**Table 4:** Cycles and the optimum feasible results under Case II for scenario 2

Cycle $k$	Number of vehicles in lanes and total of that at the beginning of the cycle $N_j(k)$ [NT(k)] $j = 1,2,3,4$	Green signal time (sec.) $t_j(k), j = 1,2,3,4$	Cycle time (sec.) $C(k)$	Aggregate delay time at the end of the cycle (sec.) $D_j(k+1), j = 1,2,3,4$	Number of vehicles in lanes at the end of the cycle $N_j(k+1), j = 1,2,3,4$
1	09 10 07 14 [40]	13 15 10 20	70	346, 504, 412, 443	05 07 04 09
2	05 07 04 09 [25]	07 10 05 12	46	124, 222, 156, 157	03 04 03 05
3	03 04 03 05 [15]	04 05 04 06	31	51, 88, 75, 83	02 02 02 03
4	02 02 02 03 [09]	02 02 02 04	22	29, 34, 37, 38	01 01 01 02
5	01 01 01 02 [05]	01 01 01 02	17	11, 13, 14, 15	01 01 01 01
6	01 01 01 01 [04]	01 01 01 01	16	10, 12, 14, 15	01 01 01 01
7	01 01 01 01 [04]	01 01 01 01	16	10, 12, 14, 15	01 01 01 01

In Table 4 given above, the results of cycle 6 and cycle 7 are the same. If this process continues more cycles, the results will be same as the results of cycle 6. Because of oversaturation situation, some vehicles are still waiting in each lane in the final cycle (cycle 6).

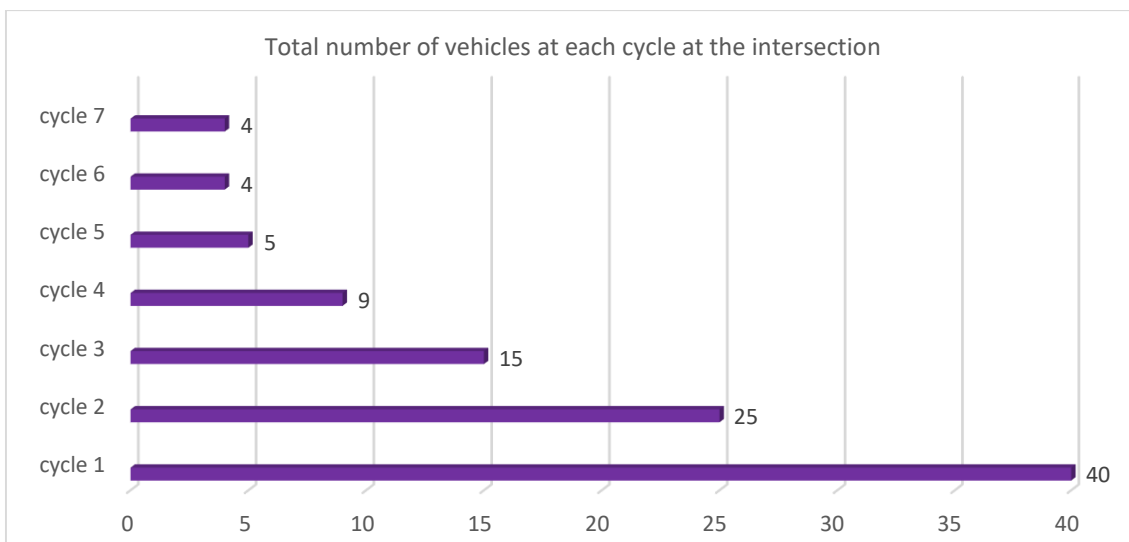

**Figure 10:** Total number of vehicles at each cycle in Lane 1, Lane 2, Lane 3 and Lane 4 under Case II for scenario 2

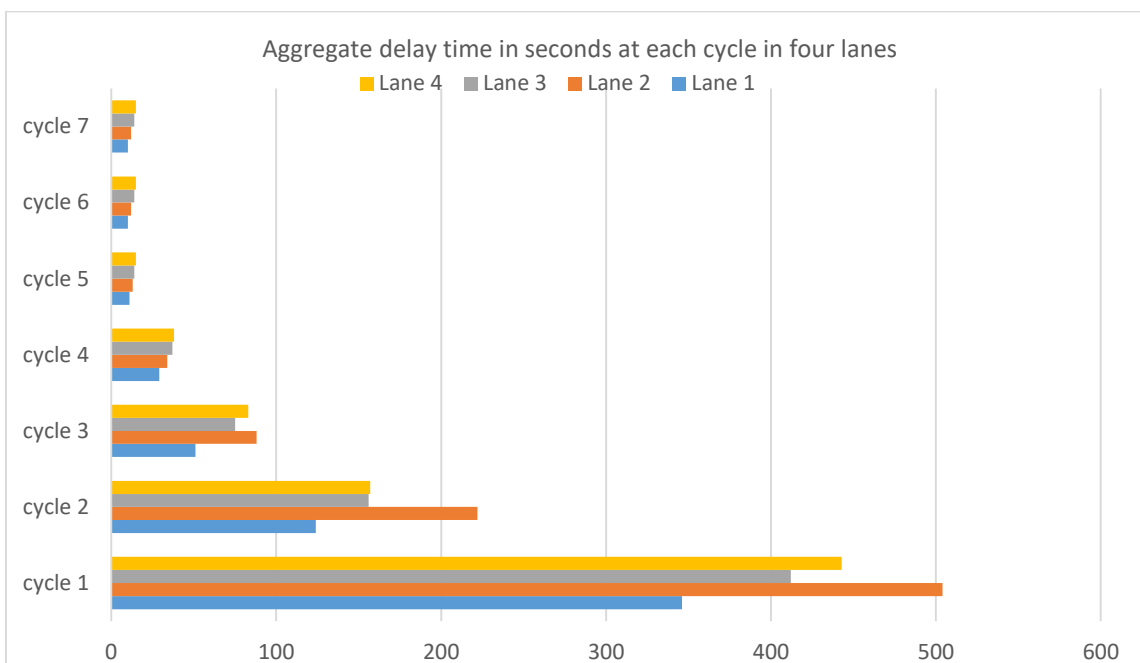

**Figure 11:** Aggregate delay time at each cycle for Lane 1, Lane 2, Lane 3 and Lane 4 under Case II for scenario 2

**5. CONCLUSION**

In this research paper, the developed models under control of two special oversaturation conditions along with some other control conditions are interfaced with the fmincon interior-point algorithm coded in MATLAB environment to create a real time optimized signal time control platform at a road intersection. In those models the incoming flow rate of vehicles at each lane is calculated during inter green-red-green signal transition time rather than cycle time. These models estimate green signal time of each signal for a particular cycle using the number of vehicles from camera reading at the beginning of that cycle. This process can continue cycle to cycle. But, we analyzed performance of vehicles only taking camera readings for the first cycle and for the rest of the other cycles, the number of vehicles at the intersection will be calculated using the results of the previous cycle. Those integrated models are applied to a hypothetical intersection. The results of the estimation show that the proposed mathematical models produce better results than the other existing optimization models.

## REFERENCES

- [1] Tang-Hsien Chang, Jen-Ting Lin, 'Optimal signal timing for an oversaturated intersection'. *Transportation Research Part B: Elsevier Science Ltd.* **34**, 471-491, 2000.
- [2] Shuaiyu Chen, 'Real-Time Traffic Signal Control for Over-Saturated Networks'. Ph.D., Dissertation, Graduate Faculty of Texas Tech University, (2007).
- [3] Vincent R. and J. Pierce. (1988). "MOVA: Traffic Responsive, Self -Optimizing Signal Control for Isolated Intersections", TRRL, Research Report, RR170.
- [4] Traffic Advisory Leaflet 3/97. (1997). The "MOVA" signal control system, Department for Transport.
- [5] Woo-Young AHN. (2004). Dynamic Signal Optimization for Isolated Road Junctions, Ph.D. Thesis, Centre for Transport Studies, University College London.
- [6] Webster, F.V., 1958. Traffic Signal Settings. Road Research Technical Paper, 39, Her Majesty's Stationary Office, London, U. K.
- [7] Zhili Tian. 2002. Capacity Analysis of Traffic Actuated Intersections, Thesis MSc. Department of Civil and Environmental Engineering, Massachusetts Institute of Technology.
- [8] Highway Capacity Manual. (2000). TRB, National Research Council, Washington, D. C.
- [9] AKCELIK. R., 'Time dependent Expressions for Delay, Stop Rate and Queue Length at Traffic signals'. Internal Report. AIR 367-1. Australian Road Research Board, Vermont South, Australia, (1980).
- [10] Mrs.P.M.Daigavane, Dr.P.R.Bajaj, 'Real Time Vehicle Detection and Counting Method for Unsupervised Traffic Video on Highways', IJCSNS International Journal of Computer Science and IJCSNS International Journal of Computer Science and Network Security, VOL.10 No.8, 2010.
- [11] Ahmet Yazici, Gangdo Seo, Umit Ozguner, 'A model predictive control approach for decentralized traffic signal control', Proc. 17th World Congress, The international federation of Automatic Control, Seoul, Korea, July 6-11, 2008.
- [12] Tang-Hsien Chang, Jen-Ting Lin., Optimal signal timing for an oversaturated intersection. *Transportation Research Part B: Elsevier Science Ltd.* **34**, 471-491, (2000).
- [13] Peng CHEN, Huan LIU, Hong-sheng QI, Fu-jian WANG, 'Analysis of delay variability at isolated signalized Intersections', *Journal of Zhejiang University-SCIENCE A (Applied Physics & Engineering)* **14**(10):691-704, (2013).
- [14] Ahmet Yazici, Gangdo Seo, Umit Ozguner., 'A model predictive control approach for decentralized traffic signal Control', Proceedings of the 17 th World Congress, The International Federation of Automatic control Seoul, Korea, (2008).